

# SLIDE 60x40

Ovales Aufsatzbecken, hergestellt aus VetrolFreddo® mit Kantenstärke 4

*Oval countertop washbasin, produced in VetrolFreddo® with edge thickness 4*

**Serie:** Slide 60x40

**Article:** Slide 60x40

**Kategorie:** Aufsatzbecken

**Category:** Countertop washbasin

**Material:** VetrolFreddo®

**Material:** VetrolFreddo®

**Überlauf:** Nein









**Overflow:** No

**Gewicht:** kg ±5,10

**Weight:** kg ±5,10

**FARBEN**  
COLOURS

|  |   |
|--|---|
| Wei matt   white<br>SLIDE60X40P001        |    |
| Puder Pink   powder pink<br>SLIDE60X40P202 |    |
| Avio Blau   avio<br>SLIDE60X40P402         |    |
| Anthrazit matt   fumo<br>SLIDE60X40P650    |    |
| Wei glnzend   white<br>SLIDE60X40BL      |    |
| Alt Messing   old brass<br>SLIDE60X40OB    |   |
| Alt Bronze   old bronze<br>SLIDE60X40BZ0   |  |
| Blattsilber   silver leaf<br>SLIDE60X40FA  |  |
| Blattkupfer   copper leaf<br>SLIDE60X40FR  |  |

|   |   |
|---|---|
| cedGelb   cedro<br>SLIDE60X40P102           |    |
| Salbei Grn   sage green<br>SLIDE60X40P302  |    |
| Grau matt   tortora<br>SLIDE60X40P450       |    |
| Schwarz matt   black<br>SLIDE60X40P030      |    |
| Ferrari Rot   ferrari red<br>SLIDE60X40PL34 |    |
| Alt Kupfer   old copper<br>SLIDE60X40CPO    |   |
| Dark Inox   old dark inox<br>SLIDE60X40DX0  |  |
| Blattgold   gold leaf<br>SLIDE60X40FO       |  |

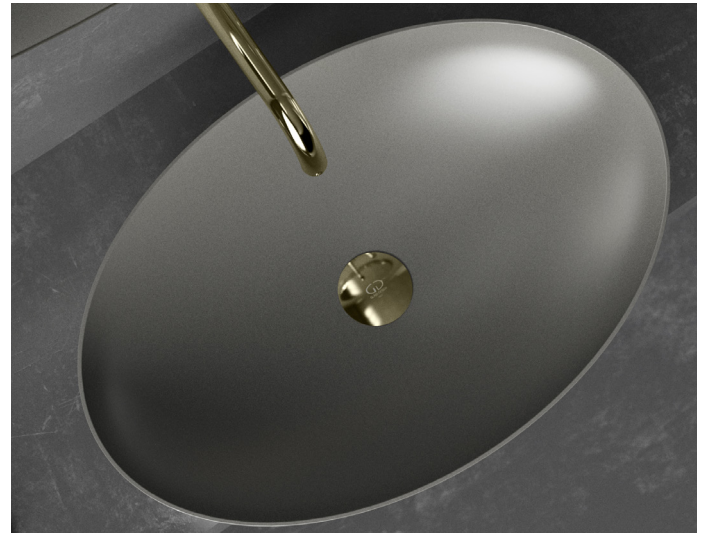

Basisring und Ablaufventil werden als Zubehr empfohlen.  
*Base ring and drain valve are recommended as accessories.*

Handgefertigtes Produkt, die Abmessungen knnen leicht variieren.  
*Handcrafted product, dimensions subject to small variations.*

**TECHNISCHE DATEN**  
TECHNICAL DATA

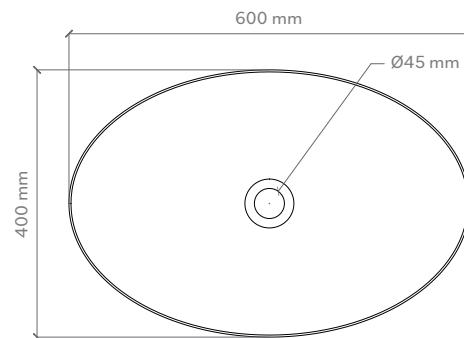
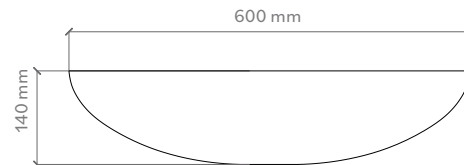
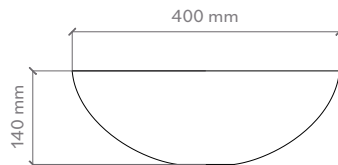

**POSITIONIERUNG VON ARMATUR UND AUFSATZBECKEN**  
TAP AND SINK POSITIONING

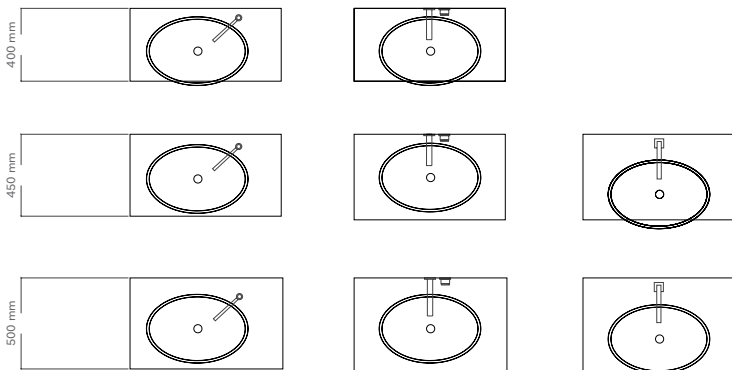

**LOCHBOHRUNG IN DER MBELPLATTE**  
HOLE ON THE TOP

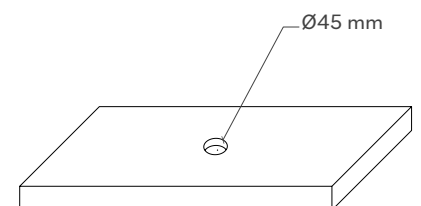

---

**MATERIALE**  
MATERIAL

VetroFreddo® ist eine Materialkomposition aus Kunstharz und Glas (Ital. kaltes Glas). Das Rohmaterial wird erhitzt und von Hand in die Beckenform gegossen. Nachdem das Material abgekühlt ist, werden alle Kanten und Radien von Hand nachbearbeitet. Die Rohmaterialien sind immer weiß matt oder schwarz matt. Alle anderen Farben und Oberflächen werden auch hier wieder von Hand aufgetragen. So wird z. B. das Blattgold Blatt für Blatt in drei Schichten auf das Becken aufgelegt. Die VetroFreddo® Becken können mit der Anti Scratch Oberfläche zusätzlich geschützt werden.

*VetroFreddo® is a material composition of synthetic resin and glass (Ital. cold glass). The raw material is heated and poured by hand into the basin mold. After the material has cooled down, all edges and radii are finished by hand. The raw materials are always white matte or black matte. All other colors and finishes are again applied by hand. For example, the gold leaf is applied to the basin in three layers, leaf by leaf. The VetroFreddo® basins can be additionally protected with the anti-scratch surface.*

---

**PFLEGE UND REINIGUNG**  
CARE AND MAINTENANCE

Bitte reinigen Sie die Produkte nur mit Wasser und neutraler Seife unter Verwendung weicher Tücher. Verwenden Sie auf keinen Fall Reinigungsmittel, die Scheuermittel oder aggressive Substanzen enthalten. Eine unsachgemäße Reinigung kann die Oberfläche der Produkte dauerhaft beschädigen. In diesem Fall kann das Unternehmen nicht für Schäden haftbar gemacht werden.

*Please clean the products with water and neutral soap only, using soft towels. Do not use for any reason cleaning solutions containing abrasive or aggressive substances. Incorrect cleaning may permanently ruin the surface of the products and in such case the company may not be held liable for damage.*